



CONVERGE® Pro 2

Next Generation Audio DSP Platform
Professional Audio Conferencing and Sound Reinforcement Systems



ClearOne® Contacts

Headquarters

5225 Wiley Post Way Suite 500
Salt Lake City, UT 84116

Sales

Tel: +1.801.975.7200
sales@clearone.com

Headquarters

Tel: +1.801.975-7200

Technical Support

Tel: +1.801.974.3760
audiotechsupport@clearone.com

Notices

© 2022 ClearOne, Inc, Inc. All rights reserved.

Information in this document is subject to change without notice.

Document: QSG-0032-001v1.6 November 2022



Important Safety Instructions

See the [safety instructions at the end of this document](#).

Unpacking

Use the illustrations below to verify that you have received all components. ClearOne is not responsible for product damage incurred during shipment. Inspect your shipment carefully for obvious signs of damage. If the shipment appears damaged, retain original boxes and packing material for inspection by the carrier, and contact them immediately. The following items are included with your CONVERGE Pro 2 (CP2) unit:

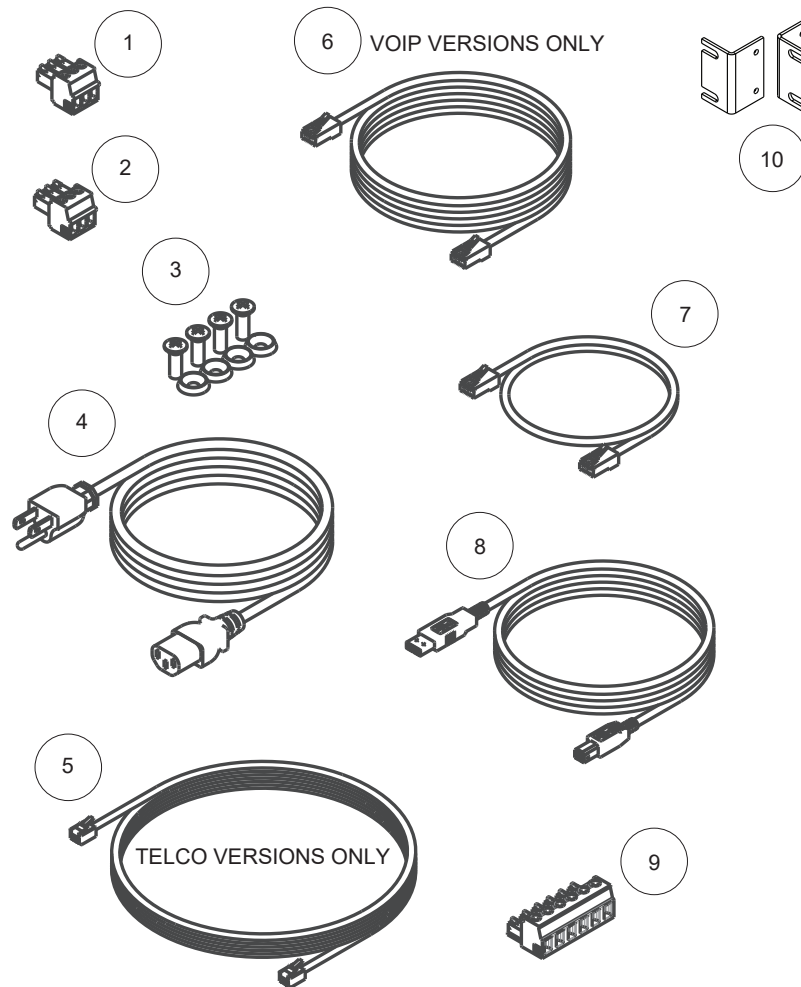

Item No.	Description	128, 128D, 128SR, 128SRD	128T, 128TD	128V, 128VD	120	012	48T	48V
1	Terminal Block Connector, 3 pos. (Orange)	12	12	12	12	0	4	4
2	Terminal Block Connector, 3-Pos. (Black)	8	8	8	0	12	8	8
3	#10-32 Screw/Washer Kit	1	1	1	1	1	1	1
4	Grounded Power Cord, 6 ft	1	1	1	1	1	1	1
5	Telephone Cable, 12 ft	0	1	0	0	0	1	0
6	RJ-45/RJ-45 Patch Cable, 7 ft	0	0	1	0	0	0	1
7	RJ-45/RJ45 Patch Cable, 18 ft	1	1	1	1	1	1	1
8	USB Type A to Type B Cable, 6 ft	1	1	1	1	1	1	1
9	Terminal Block Connector, 6 position (Green)	1	1	1	1	1	1	1
10	Rack Ears Kit	1	1	1	1	1	1	1
11	CONVERGE Pro 2 Quick Start Guide	1	1	1	1	1	1	1

Installation

Your CP2 comes with rack mount ears that fit a standard 19 in rack, and a screw/washer kit. Rack mounting eliminates the need for space between multiple units.

To change position of your rack ears:

1. Remove the two screws from each side near the front/rear (depending on which side you want facing front of rack),
2. Attach the rack ears using screws that were removed previously.

The following shows two options: 1) mounting to the front (standard) and 2) mounting to the back.

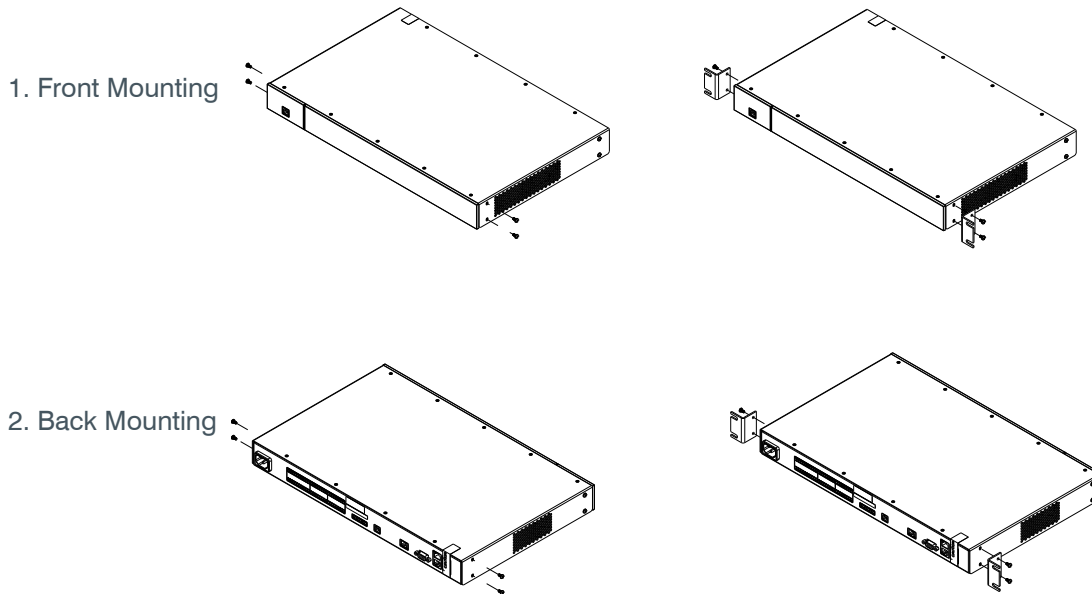

Mount the unit by securing the rack-mount ears to two posts or mounting strips in the rack using the four screws and washers provided. Because the rack-mount ears support the weight of the entire chassis, use all four screws and washers to fasten the two rack-mount brackets to the rack posts.

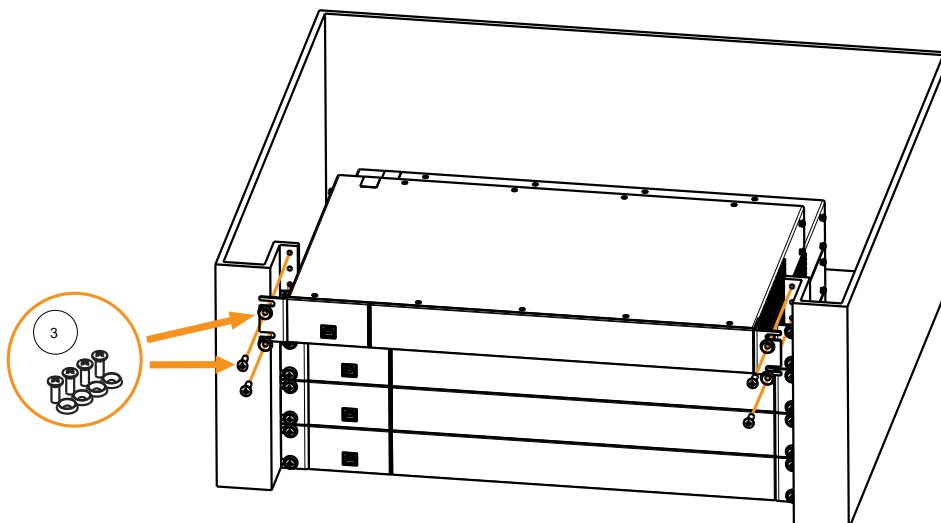



Connecting the CP2

To connect and start to use the CP2, complete the following steps in order:

1. On the back panel, **except for connecting a power source**, make all appropriate connections.

Note the following information:

Port	Notes
Type B USB Port	To connect to a computer or conferencing device for USB audio
RS-232 Serial Port	To connect to an external control device such as an AMX or Crestron controller  Note: CONSOLE AI software connects through USB or Ethernet only.
P-Link PoE Port (pass-through) and P-Link OUT Port	Detailed information is available in the PoE and CONVERGE Pro 2 P-Link Peripheral Products Application Note . LEDs adjacent to each port indicate connection status and packet traffic activity.
C-Link In and C-Link Out Ports	To connect together multiple CP2 units to create a site.  Warning: Use the C-Link In and C-Link Out ports with only CONVERGE Pro 2 Devices. Connecting any other devices to the C-Link In and C-Link Out ports, including CONVERGE Pro or Beamforming Microphone Array products results in severe equipment damage.

2. (Optional) If you want to use CONSOLE AI software to program the CP2 via USB, connect your computer to the front panel USB port.
3. Connect AC Power.

 **Warning:** This equipment must be connected to an AC mains socket outlet with a protective earthing connection. The third prong of this connector (ground) is an important safety feature. Do **not** attempt to disable this ground connection by using an adaptor or other method.

4. On the front panel, check the LEDs. Use information in the following table:

LED Name	Condition	Indication
Status	Off (no light)	The unit is still initializing.
	Solid purple	Stack syncing and booting is in progress.  Note: If, after 5 to 6 mins, the color of the CP2 status indicator does not transition from purple to another color, please contact ClearOne technical support .
	Slow blinking blue	The unit is not configured.
	Solid blue	The unit is configured.
	Fast blinking red	Stack sync error
Locate	Blinking blue	The “Locate” command has been received.
Power	Solid blue	The unit is powered-on.

Programming the CONVERGE Pro 2

CONSOLE AI software is necessary to program the CP2. It is available for download at:

<https://www.clearone.com/rl-search?combine=console+ai+software+v>

The [CONSOLE AI User Manual](#) provides detailed information.

Related Documents

The following documents are available in [ClearOne’s Resource Library](#):

- [CONVERGE Pro 2 Datasheet](#), with full specifications
- [PoE and CONVERGE Pro 2 P-Link Peripheral Products Application Note](#)
- [PoE Calculator Tool - Excel-based](#)
- [CONVERGE Pro 2 Serial Commands Reference Manual](#)





Important Safety Instructions

1. Read, follow and keep these instructions.
2. Heed all warnings.
3. Do not use this apparatus near water.
4. Clean only with dry cloth.
5. Do not block any ventilation openings. Install in accordance with the manufacturer's instructions.
6. Do not install near any heat sources such as radiators, heat registers, stoves, or other apparatus (including amplifiers) that produce heat.
7. Do not defeat the safety purpose of the polarized or grounding-type plug. A polarized plug has two blades with one wider than the other. A grounding type plug has two blades and a third grounding prong. The wide blade or the third prong are provided for your safety. If the provided plug does not fit into your outlet, consult an electrician for replacement of the obsolete outlet. The device must be connected to a earth grounded socket. For Norway: Apparatet må tilkoples jordet stikkontakt. For Sweden: Apparaten skall anslutas till jordat uttag. For Finland: Laite on liitettävä suojakoskettimilla varustettuun pistorasiaan.
8. Protect the power cord from being walked on or pinched particularly at plugs, convenience receptacles, and the point where they exit from the apparatus.
9. Only use attachments/accessories specified by the manufacturer.
10. Use only with the cart, stand, tripod, bracket, or table specified by the manufacturer, or sold with the apparatus. When a cart is used, use caution when moving the cart/apparatus combination to avoid injury from tip-over.
11. Unplug this apparatus during lightning storms or when unused for long periods of time.
12. Refer all servicing to qualified service personnel. Servicing is required when the apparatus has been damaged in any way, such as power-supply cord or plug is damaged, liquid has been spilled or objects have fallen into the apparatus, the apparatus has been exposed to rain or moisture, does not operate normally, or has been dropped.
13. Use the mains plug to disconnect the apparatus from the AC mains. The mains plug shall remain readily operable. For France: Utilisez la prise secteur pour débrancher l'appareil à partir du secteur. La prise secteur doit rester facilement accessible.
14. To completely disconnect unit power from the AC mains, disconnect the unit's power cord from the mains socket. To reconnect power, plug the unit's power cord into the mains socket following all safety instructions and guidelines. For France: Pour alimentation de l'unité de couper entièrement l'alimentation secteur, débranchez le cordon d'alimentation de l'appareil de la prise de courant. Pour rétablir le courant, branchez le cordon d'alimentation de l'appareil dans la prise de courant en suivant toutes les instructions et les directives de sécurité.
15. Caution: Danger of explosion if lithium battery is incorrectly replaced. Replace only with the same or equivalent type. Battery should only be replaced by qualified personnel and is not intended as a user serviceable part. Do not expose batteries or battery pack to excessive heat such as prolonged sunlight, fire or other heat sources. For France: Attention: Danger d'explosion si la pile au lithium est remplacée de façon incorrecte. Remplacez uniquement avec le même type ou équivalent. Batterie ne doit être remplacé par du personnel qualifié et ne vise pas comme une partie réparable par l'utilisateur. Ne pas exposer les piles ou batterie à une chaleur excessive comme la lumière du soleil prolongée, le feu ou d'autres sources de chaleur.
16. Never push objects of any kind into this product through cabinet slots as they may touch dangerous voltage points or short out parts that could result in fire or electric shock.
17. This product can interfere with electrical equipment such as tape recorders, TV sets, radios, computers and microwave ovens if placed in close proximity.
18. Class 2 Wiring is required for these devices. Wiring and install should only be performed by qualified personnel.
19. For CONVERGE Pro 2 (CP2) products that include a telephone circuit, Underwriters Laboratories (UL) requires these safety notifications:



Caution:

- To reduce the risk of fire, use only No. 26 AWG or larger UL Listed or CSA Certified Telecommunication Line Cord.
- When using your telephone equipment, basic safety precautions should always be followed to reduce the risk of fire, electric shock and injury to persons, including the following:
- Do not use this product near water for example, near a bathtub, washbowl, kitchen sink or laundry tub, in a wet basement or near a swimming pool.
- Avoid using a telephone (other than a cordless type) during an electrical storm. There may be a remote risk of electric shock from lightning.
- Do not use the telephone to report a gas leak in the vicinity of the leak.
- Use only the power cord and batteries indicated in this manual. Do not dispose of batteries in a fire. They may explode. Check with local codes for possible special disposal instructions.

<p>WARNING: TO PREVENT FIRE OR ELECTRICAL SHOCK HAZARD, DO NOT EXPOSE THIS PRODUCT TO RAIN OR MOISTURE</p>	 <p>THE LIGHTNING FLASH AND ARROWHEAD WITHIN THE TRIANGLE IS A WARNING SIGN ALERTING YOU OF DANGEROUS VOLTAGE INSIDE THE PRODUCT.</p>	<p>CAUTION</p>	 <p>THE EXCLAMATION POINT WITHIN THE TRIANGLE IS A WARNING SIGN ALERTING YOU OF IMPORTANT INSTRUCTIONS ACCOMPANYING THE PRODUCT.</p>	 <p>Use only in non-tropical locations.</p>
	<p>RISK OF ELECTRIC SHOCK DO NOT OPEN</p> <p>AVIS RISQUE DU CHOC ELECTRIQUE - NE PAS OUVRIR</p> <p>CAUTION: TO REDUCE THE RISK OF ELECTRIC SHOCK, DO NOT REMOVE COVER (OR BACK) NO USER SERVICEABLE PARTS INSIDE. REFER SERVICING TO QUALIFIED SERVICE PERSONNEL.</p>	 <p>Use only at altitudes of 2000 meters or less.</p>		
<p>SEE MARKING ON BOTTOM/BACK OF PRODUCT</p>				

Disposal

The symbol indicates that this product shall not be mixed with unsorted municipal waste when disposed of. There is a separate collection system for waste electrical and electronic equipment. For further information please contact the competent municipal authorities or the reseller from which you purchased the product. Correct disposal ensures that waste electrical and electronic equipment is recycled and reused appropriately. It helps avoid potential damage to the environment and human health and to preserve natural resources.

